

# Sorento

## Product installation and operation manual

Fully automatic induction tap

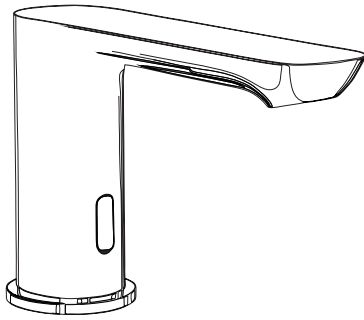

### Product parameter

Medium temperature	1-55℃
Working water pressure	0.1MPa-0.6MPa(Optimal water pressure :0.2-0.5MPa)
Induction time	≤1 second
Operating voltage	Ac220V50-60Hz, DC 6V(four No.5 alkaline batteries)
Induction range	30cm(±10%)(for standard white smooth analog plate)
Interface size	G1/2"(DN15)

### Matters needing attention

1. Before installation, the pipe must be cleaned to prevent possible damage to the solenoid valve in future use.
2. Do not install the electronic sensor in direct sunlight or strong light to avoid sensor failure.
3. Before installation, confirm that the selection is in line with the national standard alkaline battery, and correctly into the battery box, positive and negative pole can not be installed.
4. After installation, strict water test and pressure test are carried out to ensure that the inlet and outlet water terminal interface is watertight. (When the water pressure is lower than 0.05MPa, the booster device should be installed to avoid the decrease of washing effect. When the water pressure is higher than 0.7MPa, a decompression device should be installed to avoid damage to the inductor.)

### install

1. Take out the faucet, remove the fastening nut, stainless steel gasket and flat rubber pad of the faucet, lock the water inlet hose into the faucet, and then put the water inlet hose and plug line through the basin hole, through the flat rubber pad, stainless steel gasket, fastening screw, and then adjust the Angle of the faucet, lock the faucet on the basin from the bottom of the table.
2. Take out the hanging piece of the accessory control box, drill two holes with a diameter of 5.5mm and a depth of 30mm in the wall (control box as shown in the figure below), knock the expansion tube into the holes, lock the hanging piece of the control box on the expansion tube installed on the wall with self-tapping screws, hang the control box on the hanging piece, and then connect the induction line connector of the control box with the faucet induction line connector. Finally, plug the control box into the power supply.
3. Connect the water outlet hose (G1/2) on the faucet to the water outlet of the control box tightly, and then fasten one end of the double-ended hose (G1/2) to the water inlet of the control box, and the other end to the Angle valve.
4. Ensure that all pipes are free of leakage

Note: Unit: mm, size with "( )" is the recommended installation size. Specifications and dimensions are for reference only, please use physical objects as the main object during engineering operations.

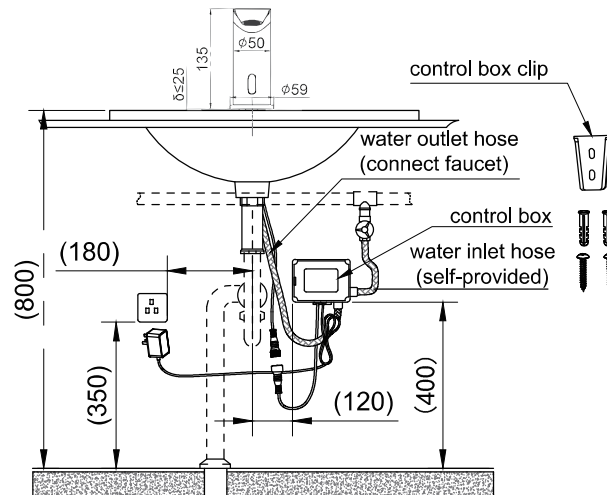

### Product function

1. Automatic flushing: Infrared sensor automatically opens and closes.
2. Timeout protection: When the flushing time exceeds 60S, the water source will be automatically shut off to avoid waste caused by long-term induction of water by different objects.
3. Low power reminder: when the battery power is not enough to provide the sensor to work normally, the automatic water off indicator quickly flashes, prompting replacement of a new battery.

### Product characteristics

1. Intelligent: Open and close the water source are automatically completed by the sensor, without human operation.
2. Hygiene: do not need to touch any switch and parts, avoid cross infection bacteria, so that your health can be guaranteed.
3. Water saving: Reach out to boil water, close the hand off the water, namely induction action, convenient water saving.
4. Power saving: Use 4 No. 5 alkaline batteries (genuine Nanfu < self-provided >), with 3000 times/month use frequency, about 2 years (laboratory theoretical test value) do not need to replace the battery. Replace the battery

### Replace the battery

If the AC power supply is used, please disconnect the power supply first, and then take off the control box, open the control box cover, take out the battery box, pull out the battery box cover to take out the old battery, and replace the new 4 5 alkaline batteries, check the positive and negative electrodes, install the battery box cover, and then install the control box cover, and hang the control box on the hanging piece.

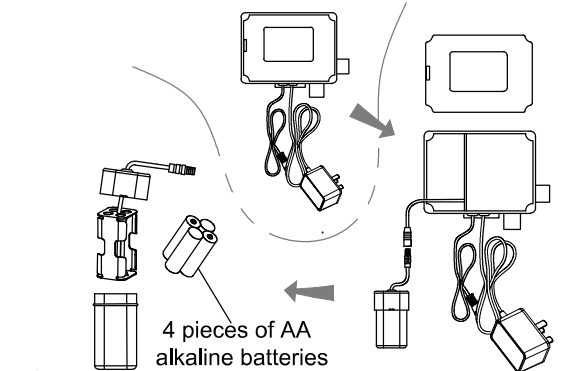

⚠ Rui Attention:

The positive and negative electrodes of the battery must be correct. Old and new batteries or batteries of different brands cannot be mixed. When the battery is exhausted, this indicator blinks three times every one second, prompting you to replace the battery. When the battery runs out of power, the sensor will force the solenoid valve to close, preventing water waste.

### Instructions for use



When the hand reaches the induction range, the tap water automatically.

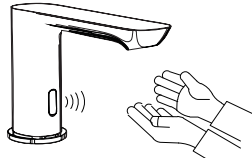

When the hand leaves the sensing range, the tap automatically shuts off the water.

### Precautions for use

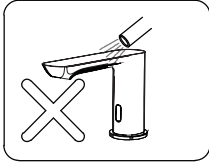

Please do not rinse the faucet with water. Clean it with a clean dry soft cotton cloth.

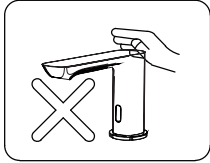

Please do not shake the faucet, otherwise it may cause trouble.

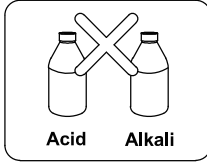

Do not scrub with acid and alkaline detergent.

### Simple fault analysis and processing

phenomenon	Cause of failure	Treatment method
No water or water	Battery run out	Replace the battery
	The sensor window is stained	Scrub dirt
	Cut off water	Wait for water
	The water inlet is clogged up	Cleaning filter
	Water pressure is out of service	Adjusting water pressure
Too little water yield	There's an obstruction in the induction window	Remove obstacles
	The inlet Angle valve is closed	Turn on the Angle valve switch
	The filter is too dirty	Cleaning filter
	There is a foreign body in of the solenoid valve of the solenoid valve	Remove foreign matt m water hole m water hole
Battery life	Low water pressure	Adjusting water pressure
	Use non-alkaline or count erfeit batteries	Replace the good al kaline battery

### Product parts breakdown diagram

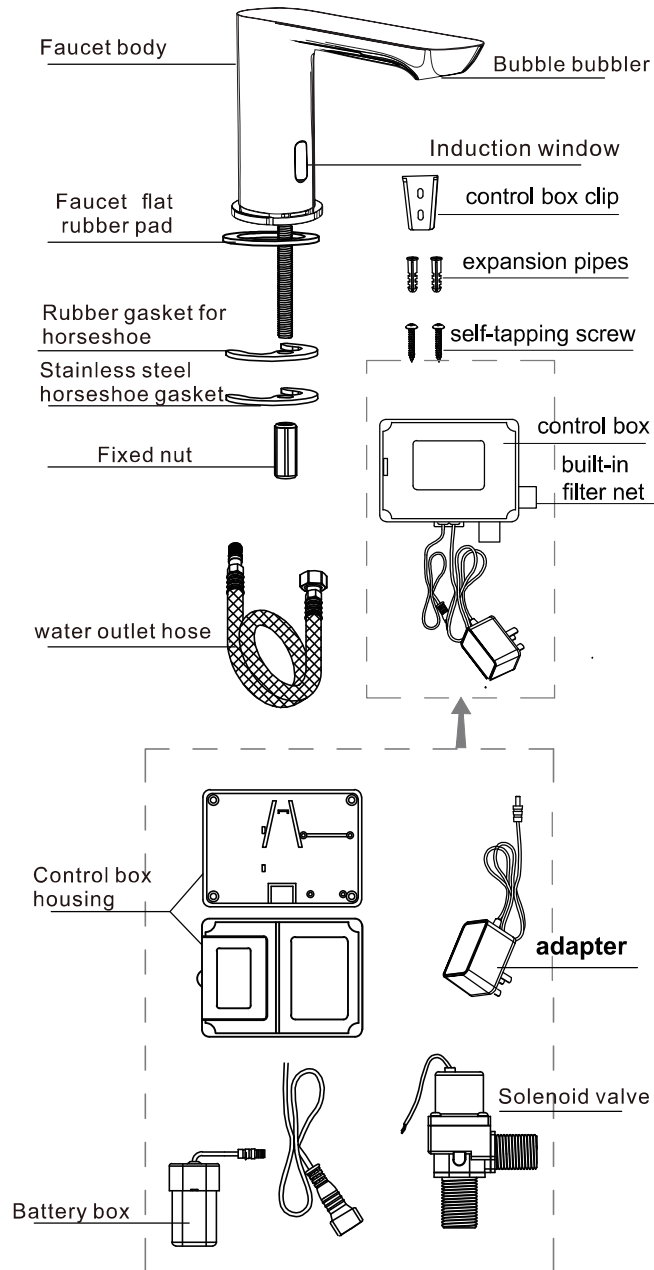

### Cleaning filter

When the sensor is used in the early stage or the induction water output is reduced, it may be blocked by the filter, it needs to be cleaned, remember to close the water source before cleaning the filter.

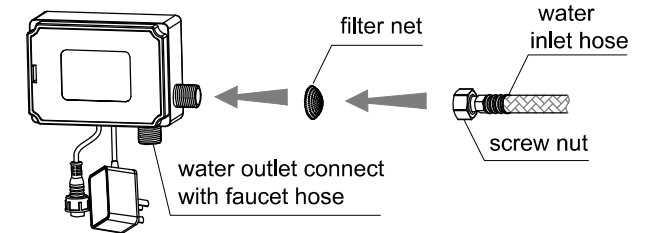

### Installation method The same type of product

